

Safety Relays

# SF-Y RELAYS

Product Catalog

**IN Your  
Future**

# SF-Y RELAYS

## Compact Flat type Safety relay compliant with European safety standards

[ Protective construction ] Sealed type

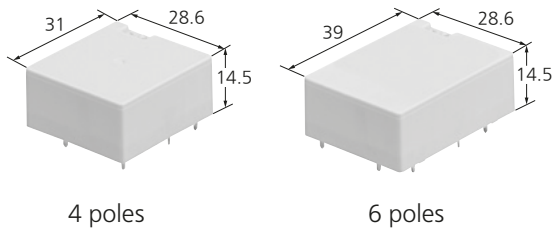

( Unit: mm )

### FEATURES

- **Forcibly guided contact structure**  
Type A, IEC61810-3 TÜV certification  
Forcibly guided contact structure that enables detection of contact welding and construction of safety circuit.
- **Small size: Length ( 39/31 mm ) × Width ( 28.6 mm ) × Height ( 14.5 mm )**
- **Wide variation in contact arrangements**  
4 poles ( 2 Form A 2 Form B, 3 Form A 1 Form B ),  
6 poles ( 4 Form A 2 Form B, 5 Form A 1 Form B )

### TYPICAL APPLICATIONS

- Safety module
- Safety PLC
- Machine tool
- Robot
- Circuits need to meet safety standards in particular, such as vehicle production equipment

### ORDERING INFORMATION ( PART NO. : Ordering part number for Japanese market)

**AG1Y 0**

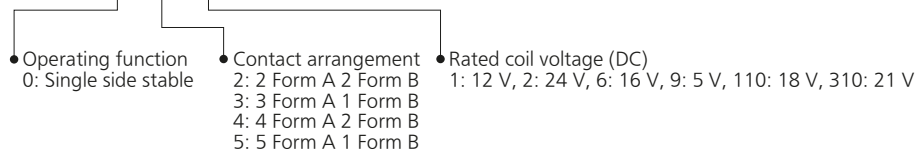

### ORDERING INFORMATION ( TYPE NO. : Ordering part number for non Japanese market)

**SFY**

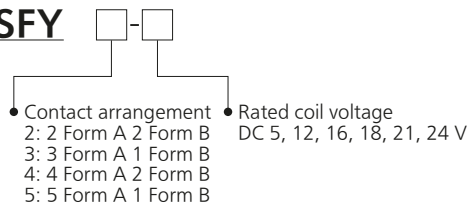

# Safety Relays SF-Y RELAYS

## TYPES

" Type No. " is ordering part number for non Japanese market. " Part No. " is ordering part number for Japanese market.

■ PC board terminal

● Tube packing

Contact arrangement		Rated coil voltage	Type No.	Part No.	Standard packing					
					Inner carton ( 1-tube )	Outer carton				
4 poles	2 Form A 2 Form B	5 V DC	SFY2-DC5V	AG1Y029	20 pcs.	200 pcs.				
		12 V DC	SFY2-DC12V	AG1Y021						
		16 V DC	SFY2-DC16V	AG1Y026						
		18 V DC	SFY2-DC18V	AG1Y02110						
		21 V DC	SFY2-DC21V	AG1Y02310						
		24 V DC	SFY2-DC24V	AG1Y022						
	3 Form A 1 Form B	5 V DC	SFY3-DC5V	AG1Y039						
		12 V DC	SFY3-DC12V	AG1Y031						
		16 V DC	SFY3-DC16V	AG1Y036						
		18 V DC	SFY3-DC18V	AG1Y03110						
		21 V DC	SFY3-DC21V	AG1Y03310						
		24 V DC	SFY3-DC24V	AG1Y032						
		6 poles	4 Form A 2 Form B	5 V DC			SFY4-DC5V	AG1Y049	20 pcs.	200 pcs.
				12 V DC			SFY4-DC12V	AG1Y041		
16 V DC	SFY4-DC16V			AG1Y046						
18 V DC	SFY4-DC18V			AG1Y04110						
21 V DC	SFY4-DC21V			AG1Y04310						
24 V DC	SFY4-DC24V		AG1Y042							
5 Form A 1 Form B	5 V DC		SFY5-DC5V	AG1Y059						
	12 V DC		SFY5-DC12V	AG1Y051						
	16 V DC		SFY5-DC16V	AG1Y056						
	18 V DC		SFY5-DC18V	AG1Y05110						
	21 V DC	SFY5-DC21V	AG1Y05310							
24 V DC	SFY5-DC24V	AG1Y052								

# Safety Relays SF-Y RELAYS

## RATING

### Coil data

- Operating characteristics such as "Operate voltage" and "Release voltage" are influenced by mounting conditions or ambient temperature, etc.  
Therefore, please use the relay within  $\pm 5\%$  of rated coil voltage.
- "Initial" means the condition of products at the time of delivery.

Contact arrangement		Rated coil voltage	Operate voltage* ( at 20°C )	Release voltage* ( at 20°C )	Rated operating current ( $\pm 10\%$ , at 20°C )	Coil resistance ( $\pm 10\%$ , at 20°C )	Rated operating power	Max. allowable voltage ( at 20°C )
4 poles	2 Form A 2 Form B	5 V DC	Max. 75% V of rated coil voltage ( Initial )	Min. 15% V of rated coil voltage ( Initial )	134 mA	38 $\Omega$	670 mW	120% V of rated coil voltage
		12 V DC			56 mA	215 $\Omega$		
		16 V DC			42 mA	380 $\Omega$		
		18 V DC			37 mA	483 $\Omega$		
		21 V DC			32 mA	666 $\Omega$		
		24 V DC			28 mA	864 $\Omega$		
	3 Form A 1 Form B	5 V DC			134 mA	38 $\Omega$		
		12 V DC			56 mA	215 $\Omega$		
		16 V DC			42 mA	380 $\Omega$		
		18 V DC			37 mA	483 $\Omega$		
		21 V DC			32 mA	666 $\Omega$		
		24 V DC			28 mA	864 $\Omega$		
6 poles	4 Form A 2 Form B	5 V DC	134 mA	38 $\Omega$				
		12 V DC	56 mA	215 $\Omega$				
		16 V DC	42 mA	380 $\Omega$				
		18 V DC	37 mA	483 $\Omega$				
		21 V DC	32 mA	666 $\Omega$				
		24 V DC	28 mA	864 $\Omega$				
	5 Form A 1 Form B	5 V DC	134 mA	38 $\Omega$				
		12 V DC	56 mA	215 $\Omega$				
		16 V DC	42 mA	380 $\Omega$				
		18 V DC	37 mA	483 $\Omega$				
		21 V DC	32 mA	666 $\Omega$				
		24 V DC	28 mA	864 $\Omega$				

\* square, pulse drive ( JIS C 5442 )

# Safety Relays SF-Y RELAYS

## ■ Specifications

Item	Specifications			
	4 poles		6 poles	
Contact arrangement	2 Form A 2 Form B	3 Form A 1 Form B	4 Form A 2 Form B	5 Form A 1 Form B
Contact resistance ( initial )	Max. 100 mΩ ( by voltage drop 6 V DC 1 A )			
Contact material	Au-flashed AgNi type			
Contact rating ( resistive )	6 A 250 V AC, 6 A 30 V DC			
Contact data	Max. switching power ( resistive )	1,500 VA, 180 W		
	Max. switching voltage	250 V AC, 30 V DC		
	Max. switching current	6 A		
	Min. switching load ( reference value ) *1	10 mA 10 V DC		
Insulation resistance ( initial )	Min. 1,000 MΩ ( at 500 V DC, Measured portion is the same as the case of dielectric strength. )			
Dielectric strength ( initial )	Between open contacts	1,500 Vrms for 1 min ( detection current: 10 mA )		
	Between contact sets	4,000 Vrms for 1 min ( detection current: 10 mA )		
	Between contact and coil	N.C. 3 side: 2,500 Vrms for 1 min ( detection current: 10 mA ), N.O. 4 side: 4,000 Vrms for 1 min ( detection current: 10 mA )		
Coil holding voltage ( initial ) *4	Min. 60% V ( at 20°C )			
Time characteristics ( initial )	Operate time	Max. 20 ms at rated coil voltage ( at 20°C, without bounce )		
	Release time	Max. 10 ms at rated coil voltage ( at 20°C, without bounce, without diode )		
Shock resistance	Functional	200 m/s <sup>2</sup> ( half-sine shock pulse: 11 ms, detection time: 10 μs )		
	Destructive	1,000 m/s <sup>2</sup> ( half-sine shock pulse: 6 ms )		
Vibration resistance	Functional	10 to 55 Hz at double amplitude of 1.5 mm ( detection time: 10 μs )		
	Destructive	10 to 55 Hz at double amplitude of 1.5 mm		
Expected life	Mechanical life	Min. 10 x 10 <sup>6</sup> ( switching frequency 180 times/min. )		
Protective construction	RT III*3			
Conditions	Conditions for usage, transport and storage *2	Ambient temperature: -40 to +70°C, Humidity: 5 to 85% RH ( Avoid icing and condensation )		
Unit weight	Approx. 19 g		Approx. 23 g	

\*1. This value is a rough indication of the lower limit at which switching is possible at micro load level.

This value can change due to the switching frequency, environmental conditions, and desired reliability level, therefore it is recommended to check this with the actual load.

\*2. For ambient temperature, please refer to the "GUIDELINES FOR RELAY USAGE".

\*3. According to "EN 61810-1:2010, table 2".

Characteristic is sealed construction with terminals, case and base sealed shut with sealing resin. Construction is designed to prevent seeping of flux when soldering and cleaning fluid when cleaning. Harmful substances on the contacts are removed by gas purging before sealing with.

\*4. Coil holding voltage is the coil voltage after 100 ms from the applied rated coil voltage.

## ■ Electrical life

Conditions: Resistive load, switching frequency 20 times/min

Type	Switching capacity	Number of operations
2 Form A 2 Form B, 3 Form A 1 Form B, 4 Form A 2 Form B, 5 Form A 1 Form B	6 A 250 V AC	Min. 100 x 10 <sup>3</sup>
	6 A 30 V DC	Min. 100 x 10 <sup>3</sup>

## INSULATION PERFORMANCE

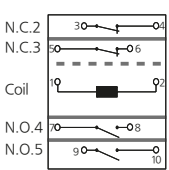
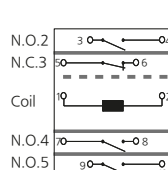
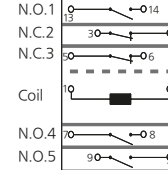
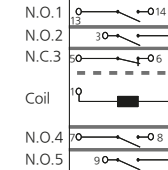
2 Form A 2 Form B	3 Form A 1 Form B	4 Form A 2 Form B	5 Form A 1 Form B
			

— Reinforced insulation: overvoltage category III, pollution degree 2, 250 V AC (Clearance and creepage distance is 5.5 mm or more between contact sets shown by "—". Also, there is 5.5 mm or more clearance and creepage distance even between contact N.O. 4 and coil. )

- - - Basic insulation: overvoltage category III, pollution degree 3, 250 V AC ( Between contact N.C. 3 and coil shown by "- - -", the clearance is 3 mm or more and the creepage distance is 4 mm or more. )

# Safety Relays SF-Y RELAYS

## OPERATION (WHEN CONTACTS ARE WELDED)

The table below shows the state of the other contacts when the current through the welded N.O. contact is 0 V and the Max. applied voltage ( 120% V of rated coil voltage ) is applied to the coil through the welded N.C. contact.

### ■ 4 poles

#### ● 2 Form A 2 Form B

		State of other contacts			
		3-4 ( N.C. )	5-6 ( N.C. )	7-8 ( N.O. )	9-10 ( N.O. )
Welded terminal No.	3-4 ( N.C. )	—		> 0.5	> 0.5
	5-6 ( N.C. )		—	> 0.5	> 0.5
	7-8 ( N.O. )	> 0.5	> 0.5	—	
	9-10 ( N.O. )	> 0.5	> 0.5		—

#### ● 3 Form A 1 Form B

		State of other contacts			
		3-4 ( N.C. )	5-6 ( N.C. )	7-8 ( N.O. )	9-10 ( N.O. )
Welded terminal No.	3-4 ( N.C. )	—	> 0.5	> 0.5	> 0.5
	5-6 ( N.C. )	> 0.5	—		
	7-8 ( N.O. )	> 0.5		—	
	9-10 ( N.O. )	> 0.5			—

### ■ 6 poles

#### ● 4 Form A 2 Form B

		State of other contacts					
		3-4 ( N.C. )	5-6 ( N.C. )	7-8 ( N.O. )	9-10 ( N.O. )	11-12 ( N.O. )	13-14 ( N.O. )
Welded terminal No.	3-4 ( N.C. )	—		> 0.5	> 0.5	> 0.5	> 0.5
	5-6 ( N.C. )		—	> 0.5	> 0.5	> 0.5	> 0.5
	7-8 ( N.O. )	> 0.5	> 0.5	—			
	9-10 ( N.O. )	> 0.5	> 0.5		—		
	11-12 ( N.O. )	> 0.5	> 0.5			—	
	13-14 ( N.O. )	> 0.5	> 0.5				—

#### ● 5 Form A 1 Form B

		State of other contacts					
		3-4 ( N.O. )	5-6 ( N.C. )	7-8 ( N.O. )	9-10 ( N.O. )	11-12 ( N.O. )	13-14 ( N.O. )
Welded terminal No.	3-4 ( N.O. )	—	> 0.5	> 0.5	> 0.5	> 0.5	> 0.5
	5-6 ( N.C. )	> 0.5	—				
	7-8 ( N.O. )	> 0.5		—			
	9-10 ( N.O. )	> 0.5			—		
	11-12 ( N.O. )	> 0.5				—	
	13-14 ( N.O. )	> 0.5					—

> 0.5: Contact gap Min. 0.5 mm

Empty cells: Contact is ON or OFF state.

Note) Contact gaps are shown at the initial state. If the contacts change state owing to switching it is necessary to check the actual loading.

# Safety Relays SF-Y RELAYS

## DIMENSIONS

**CAD** The CAD data of the products with a "CAD" mark can be downloaded from our Website.

Unit: mm

### 4 poles ( 2 Form A 2 Form B, 3 Form A 1 Form B )

**CAD**

External dimensions

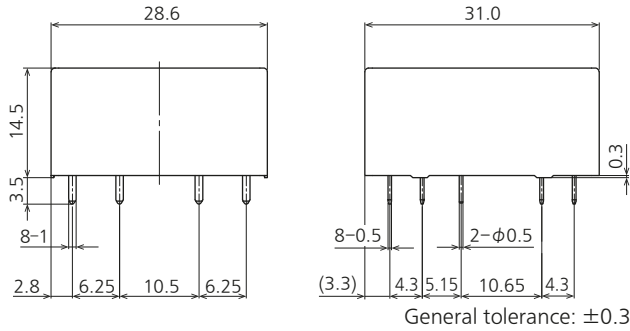

Schematic  
( BOTTOM VIEW )

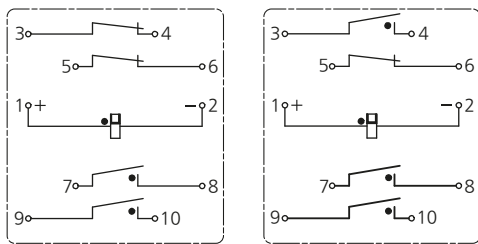

( 2 Form A 2 Form B ) ( 3 Form A 1 Form B )

Recommended PC board pattern  
( BOTTOM VIEW )

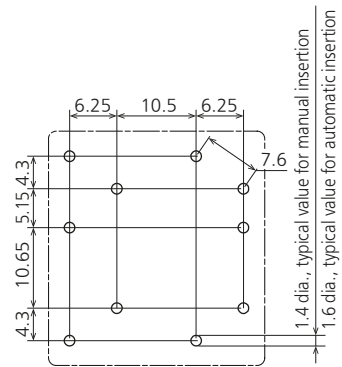

Tolerance: ±0.1

### 6 poles ( 4 Form A 2 Form B, 5 Form A 1 Form B )

**CAD**

External dimensions

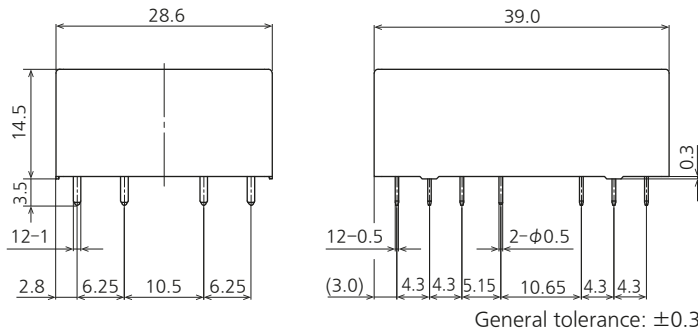

Schematic  
( BOTTOM VIEW )

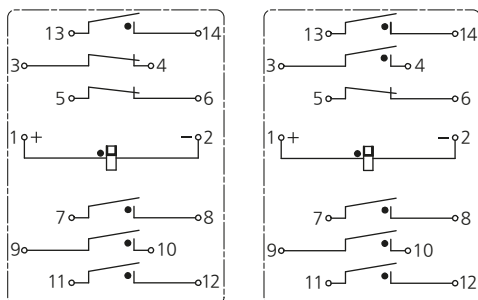

( 4 Form A 2 Form B ) ( 5 Form A 1 Form B )

Recommended PC board pattern  
( BOTTOM VIEW )

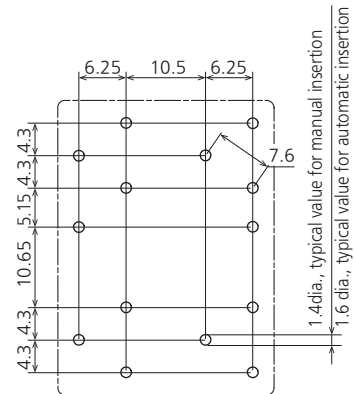

Tolerance: ±0.1

# Safety Relays SF-Y RELAYS

**SAFETY STANDARDS** Each standard may be updated at any time, so please check our Website for the latest information.

## ■ UL/C-UL ( Approved )

File No.	Contact rating	Operations	Ambient temperature
E120782	6 A 250 V AC, general use	100 x 10 <sup>3</sup>	70°C
	6 A 30 V DC, general use	100 x 10 <sup>3</sup>	70°C
	B 300, R 300 ( Pilot duty )	—	—

## ■ TÜV ( Approved )

File No.	Contact rating	Operations	Ambient temperature
968/EZ 535.00/12	6 A 230 V AC ( cos $\phi$ = 1.0 ) resistive	100 x 10 <sup>3</sup>	70°C
	6 A 24 V DC ( cos $\phi$ = 1.0 ) resistive	100 x 10 <sup>3</sup>	70°C

Note) Forcibly guided contact structure IEC61810-3 ( Type A ) standard approved by TÜV.

## ■ CSA ( Approved )

CSA standard approved by C-UL

## GUIDELINES FOR USAGE

### ■ For cautions for use, please read "GUIDELINES FOR RELAY USAGE".

[https://industrial.panasonic.com/ac/e/control/relay/cautions\\_use/index.jsp](https://industrial.panasonic.com/ac/e/control/relay/cautions_use/index.jsp)

### ■ Cautions for use SF-Y relays

#### ● Coil drive power supply

Pure DC current should be applied to the coil. If it includes ripple, the ripple factor should be less than 5%. However, check it with the actual use since the characteristics may be slightly different. Also, the power wave form should be rectangular.

#### ● Connection of coil

The positive ( + ) and negative ( - ) connections of polarized relay to the coil should be done as indicated on the schematic diagram. If connected incorrectly, it may malfunction, abnormal heat, fire or fail to operate.

#### ● Soldering

When using automatic soldering, the following conditions are recommended

- 1 ) Preheating: 120°C, within 120 sec
- 2 ) Soldering: 260 ±5°C, within 6 sec



- For cautions for use, please read " GUIDELINES FOR RELAY USAGE ".  
[https://industrial.panasonic.com/ac/e/control/relay/cautions\\_use/index.jsp](https://industrial.panasonic.com/ac/e/control/relay/cautions_use/index.jsp)

## Precautions for Coil Input

### ■ Long term current carrying

A circuit that will be carrying a current continuously for long periods without relay switching operation. ( circuits for emergency lamps, alarm devices and error inspection that, for example, revert only during malfunction and output warnings with form B contacts ) Continuous, long-term current to the coil will facilitate deterioration of coil insulation and characteristics due to heating of the coil itself. For circuits such as these, please use a magnetic-hold type latching relay. If you need to use a single stable relay, use a sealed type relay that is not easily affected by ambient conditions and make a failsafe circuit design that considers the possibility of contact failure or disconnection.

### ■ DC Coil operating power

Steady state DC current should be applied to the coil. The wave form should be rectangular. If it includes ripple, the ripple factor should be less than 5 %. However, please check with the actual circuit since the electrical characteristics may vary. The rated coil voltage should be applied to the coil and the set/reset pulse time of latching type relay differs for each relays, please refer to the relay's individual specifications.

### ■ Coil connection

When connecting coils of polarized relays, please check coil polarity ( + , - ) at the internal connection diagram ( Schematic ). If any wrong connection is made, it may cause unexpected malfunction, like abnormal heat, fire and so on, and circuit do not work. Avoid impressing voltages to the set coil and reset coil at the same time.

### ■ Maximum allowable voltage and temperature rise

Proper usage requires that the rated coil voltage be impressed on the coil. Note, however, that if a voltage greater than or equal to the maximum continuous voltage is impressed on the coil, the coil may burn or its layers short due to the temperature rise. Furthermore, do not exceed the usable ambient temperature range listed in the catalog.

#### ● Operate voltage change due to coil temperature rise

In DC relays, after continuous passage of current in the coil, if the current is turned OFF, then immediately turned ON again, due to the temperature rise in the coil, the operate voltage will become somewhat higher. Also, it will be the same as using it in a higher temperature atmosphere. The resistance/temperature relationship for copper wire is about 0.4 % for 1 °C, and with this ratio the coil resistance increases. That is, in order to operate of the relay, it is necessary that the voltage be higher than the operate voltage and the operate voltage rises in accordance with the increase in the resistance value. However, for some polarized relays, this rate of change is considerably smaller.

## Ambient Environment

### ■ Usage, Transport, and Storage Conditions

During usage, storage, or transportation, avoid locations subjected to direct sunlight and maintain normal temperature, humidity and pressure conditions.

#### ●Temperature/Humidity/Pressure

When transporting or storing relays while they are tube packaged, there are cases the temperature may differ from the allowable range. In this case be sure to check the individual specifications.

Also allowable humidity level is influenced by temperature, please check charts shown below and use relays within mentioned conditions. ( Allowable temperature values differ for each relays, please refer to the relay's individual specifications. )

##### 1) Temperature:

The tolerance temperature range differs for each relays, please refer to the relay's individual specifications

##### 2) Humidity: 5 to 85 % RH

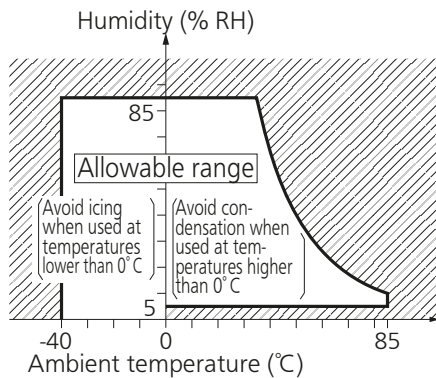

##### 3) Pressure: 86 to 106 kPa

#### ●Dew condensation

Condensation occurs when the ambient temperature drops suddenly from a high temperature and humidity, or the relay is suddenly transferred from a low ambient temperature to a high temperature and humidity.

Condensation causes the failures like insulation deterioration, wire disconnection and rust etc.

Panasonic Industry Co., Ltd. does not guarantee the failures caused by condensation.

The heat conduction by the equipment may accelerate the cooling of device itself, and the condensation may occur.

Please conduct product evaluations in the worst condition of the actual usage. ( Special attention should be paid when high temperature heating parts are close to the device. Also please consider the condensation may occur inside of the device. )

#### ●Icing

Condensation or other moisture may freeze on relays when the temperature become lower than 0 °C. This icing causes the sticking of movable portion, the operation delay and the contact conduction failure etc. Panasonic Industry Co., Ltd. does not guarantee the failures caused by the icing.

The heat conduction by the equipment may accelerate the cooling of relay itself and the icing may occur.

Please conduct product evaluations in the worst condition of the actual usage.

#### ●Low temperature and low humidity

The plastic becomes brittle if the relay is exposed to a low temperature, low humidity environment for long periods of time.

#### ●High temperature and high humidity

Storage for extended periods of time ( including transportation periods ) at high temperature or high humidity levels or in atmospheres with organic gases or sulfide gases may cause a sulfide film or oxide film to form on the surfaces of the contacts and/or it may interfere with the functions. Check out the atmosphere in which the units are to be stored and transported.

#### ●Package

In terms of the packing format used, make every effort to keep the effects of moisture, organic gases and sulfide gases to the absolute minimum.

#### ●Silicon

When a source of silicone substances ( silicone rubber, silicone oil, silicone coating materials and silicone filling materials etc. ) is used around the relay, the silicone gas ( low molecular siloxane etc. ) may be produced.

This silicone gas may penetrate into the inside of the relay. When the relay is kept and used in this condition, silicone compound may adhere to the relay contacts which may cause the contact failure. Do not use any sources of silicone gas around the relay ( Including plastic sealed types ).

#### ●NOx Generation

When relay is used in an atmosphere high in humidity to switch a load which easily produces an arc, the NOx created by the arc and the water absorbed from outside the relay combine to produce nitric acid.

This corrodes the internal metal parts and adversely affects operation.

Avoid use at an ambient humidity of 85 % RH or higher ( at 20 °C ). If use at high humidity is unavoidable, please contact our sales representative.

## Others

### ■ Cleaning

- Although the environmentally sealed type relay ( plastic sealed type, etc. ) can be cleaned, avoid immersing the relay into cold liquid ( such as cleaning solvent ) immediately after soldering. Doing so may deteriorate the sealing performance.
- Cleaning with the boiling method is recommended ( The temperature of cleaning liquid should be 40 °C or lower ). Avoid ultrasonic cleaning on relays. Use of ultrasonic cleaning may cause breaks in the coil or slight sticking of the contacts due to ultrasonic energy.

Please refer to "**the latest product specifications**" when designing your product.

- Requests to customers:

<https://industrial.panasonic.com/ac/e/salespolicies/>

■ Global Sales Network Information: [industrial.panasonic.com/ac/e/salesnetwork](https://industrial.panasonic.com/ac/e/salesnetwork)

---

**Panasonic**  
INDUSTRY

**Panasonic Industry Co., Ltd.**

Electromechanical Control Business Division

■ 1006, Oaza Kadoma, Kadoma-shi, Osaka 571-8506, Japan  
[industrial.panasonic.com/ac/e/](https://industrial.panasonic.com/ac/e/)