

Power Relays (Over 2 A)

DJ RELAYS

Product Catalog

**IN Your
Future**

DJ RELAYS

High insulation, 1-pole/2-pole 16 A, Polarized power relays

Protective construction : Flux-resistant type/Sealed type

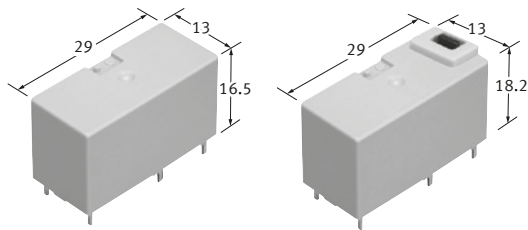

Standard type

With a test button

(Unit : mm)

FEATURES

- High insulation (between contact and coil) :
Min. 8 mm insulation distance
- Variety of contact arrangements:
1-pole (1 Form A, 1 Form B, 1 Form C) /
2-pole (1 Form A 1 Form B, 2 Form A, 2 Form B, 2 Form C)
- Latching types are available
- With test button type (Operation check function) :
1-pole only (1 Form A, 1 Form B, 1 Form C)

TYPICAL APPLICATIONS

- Industrial machine
- Electric power devices
- Household appliance networks
- Time switches

ORDERING INFORMATION (PART NO.)

ADJ

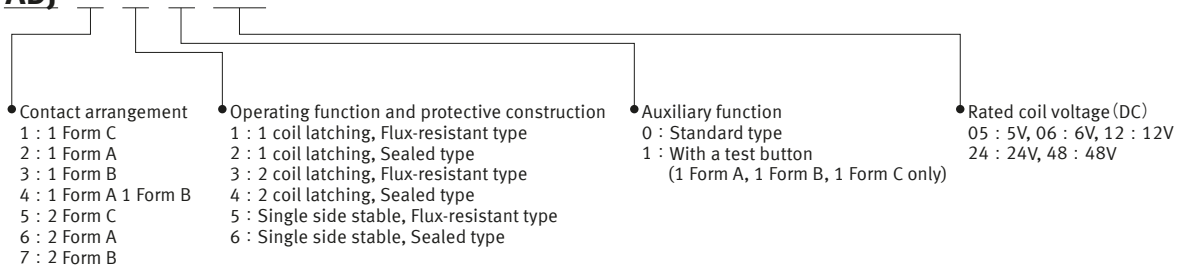

Power Relays (Over 2 A) DJ RELAYS

TYPES

■ Standard type

● Flux-resistant

Contact arrangement	Rated coil voltage	Part No.			Standard packing	
		Single side stable	1 coil latching	2 coil latching	Inner carton	Outer carton
1 Form C	5 V DC	ADJ15005	ADJ11005	ADJ13005	100 pcs.	500 pcs.
	6 V DC	ADJ15006	ADJ11006	ADJ13006		
	12 V DC	ADJ15012	ADJ11012	ADJ13012		
	24 V DC	ADJ15024	ADJ11024	ADJ13024		
	48 V DC	ADJ15048	ADJ11048	ADJ13048		
1 Form A	5 V DC	ADJ25005	ADJ21005	ADJ23005		
	6 V DC	ADJ25006	ADJ21006	ADJ23006		
	12 V DC	ADJ25012	ADJ21012	ADJ23012		
	24 V DC	ADJ25024	ADJ21024	ADJ23024		
	48 V DC	ADJ25048	ADJ21048	ADJ23048		
1 Form B	5 V DC	ADJ35005	Please use 1 Form A.	Please use 1 Form A.		
	6 V DC	ADJ35006				
	12 V DC	ADJ35012				
	24 V DC	ADJ35024				
	48 V DC	ADJ35048				
1 Form A 1 Form B	5 V DC	ADJ45005	ADJ41005	ADJ43005		
	6 V DC	ADJ45006	ADJ41006	ADJ43006		
	12 V DC	ADJ45012	ADJ41012	ADJ43012		
	24 V DC	ADJ45024	ADJ41024	ADJ43024		
	48 V DC	ADJ45048	ADJ41048	ADJ43048		
2 Form C	5 V DC	ADJ55005	ADJ51005	ADJ53005		
	6 V DC	ADJ55006	ADJ51006	ADJ53006		
	12 V DC	ADJ55012	ADJ51012	ADJ53012		
	24 V DC	ADJ55024	ADJ51024	ADJ53024		
	48 V DC	ADJ55048	ADJ51048	ADJ53048		
2 Form A	5 V DC	ADJ65005	ADJ61005	ADJ63005		
	6 V DC	ADJ65006	ADJ61006	ADJ63006		
	12 V DC	ADJ65012	ADJ61012	ADJ63012		
	24 V DC	ADJ65024	ADJ61024	ADJ63024		
	48 V DC	ADJ65048	ADJ61048	ADJ63048		
2 Form B	5 V DC	ADJ75005	Please use 2 Form A.	Please use 2 Form A.		
	6 V DC	ADJ75006				
	12 V DC	ADJ75012				
	24 V DC	ADJ75024				
	48 V DC	ADJ75048				

■ With test button type

● Flux-resistant

Contact arrangement	Rated coil voltage	Part No.			Standard packing	
		Single side stable	1 coil latching	2 coil latching	Inner carton	Outer carton
1 Form C	5 V DC	ADJ15105	ADJ11105	ADJ13105	100 pcs.	500 pcs.
	6 V DC	ADJ15106	ADJ11106	ADJ13106		
	12 V DC	ADJ15112	ADJ11112	ADJ13112		
	24 V DC	ADJ15124	ADJ11124	ADJ13124		
	48 V DC	ADJ15148	ADJ11148	ADJ13148		
1 Form A	5 V DC	ADJ25105	ADJ21105	ADJ23105		
	6 V DC	ADJ25106	ADJ21106	ADJ23106		
	12 V DC	ADJ25112	ADJ21112	ADJ23112		
	24 V DC	ADJ25124	ADJ21124	ADJ23124		
	48 V DC	ADJ25148	ADJ21148	ADJ23148		
1 Form B	5 V DC	ADJ35105	Please use 1 Form A.	Please use 1 Form A.		
	6 V DC	ADJ35106				
	12 V DC	ADJ35112				
	24 V DC	ADJ35124				
	48 V DC	ADJ35148				

Power Relays (Over 2 A) DJ RELAYS

RATING

Coil data

- Operating characteristics such as " Operate voltage " and " Release voltage " are influenced by mounting conditions or ambient temperature, etc.
Therefore, please use the relay within $\pm 5\%$ of rated coil voltage.
- " Initial " means the condition of products at the time of delivery.

Single side stable

Rated coil voltage	Operate voltage* (at 20 °C)	Release voltage* (at 20 °C)	Rated operating current ($\pm 10\%$, at 20 °C)	Coil resistance ($\pm 10\%$, at 20 °C)	Rated operating power	Max. allowable voltage (at 20 °C)
5 V DC	Max. 75 % V of rated coil voltage (Initial)	Min. 10 % V of rated coil voltage (Initial)	50 mA	100 Ω	250 mW	130 % V of rated coil voltage
6 V DC			41.7 mA	144 Ω		
12 V DC			20.8 mA	576 Ω		
24 V DC			10.4 mA	2,304 Ω		
48 V DC			5.2 mA	9,216 Ω		

* square, pulse drive

1 coil latching

Rated coil voltage	Set voltage* (at 20 °C)	Reset voltage* (at 20 °C)	Rated operating current ($\pm 10\%$, at 20 °C)		Coil resistance ($\pm 10\%$, at 20 °C)		Rated operating power	Max. allowable voltage (at 20 °C)
			Set coil	Reset coil	Set coil	Reset coil		
5 V DC	Max. 70 % V of rated coil voltage (Initial)	Max. 70 % V of rated coil voltage (Initial)	29.9 mA	29.9 mA	167 Ω	167 Ω	150 mW	130 % V of rated coil voltage
6 V DC			25 mA	25 mA	240 Ω	240 Ω		
12 V DC			12.5 mA	12.5 mA	960 Ω	960 Ω		
24 V DC			6.3 mA	6.3 mA	3,840 Ω	3,840 Ω		
48 V DC			3.1 mA	3.1 mA	15,360 Ω	15,360 Ω		

* square, pulse drive

2 coil latching

Rated coil voltage	Set voltage* (at 20 °C)	Reset voltage* (at 20 °C)	Rated operating current ($\pm 10\%$, at 20 °C)		Coil resistance ($\pm 10\%$, at 20 °C)		Rated operating power	Max. allowable voltage (at 20 °C)
			Set coil	Reset coil	Set coil	Reset coil		
5 V DC	Max. 70 % V of rated coil voltage (Initial)	Max. 70 % V of Rated coil voltage (Initial)	50 mA	50 mA	100 Ω	100 Ω	250 mW	130 % V of rated coil voltage
6 V DC			41.7 mA	41.7 mA	144 Ω	144 Ω		
12 V DC			20.8 mA	20.8 mA	576 Ω	576 Ω		
24 V DC			10.4 mA	10.4 mA	2,304 Ω	2,304 Ω		
48 V DC			5.2 mA	5.2 mA	9,216 Ω	9,216 Ω		

* square, pulse drive

Power Relays (Over 2 A) DJ RELAYS

■ Specifications

Item		Specifications	
Contact data	Contact arrangement	1 Form C, 1 Form A, 1 Form B	1 Form A 1 Form B, 2 Form C, 2 Form A, 2 Form B
	Contact resistance (initial)	Max. 100 mΩ (by voltage drop 6 V DC 1 A)	
	Contact material	AgSnO ₂ type	Au-flashed AgSnO ₂ type
	Contact rating (resistive)	16 A 250 V AC	10 A 250 V AC
	Max. switching power (resistive)	4,000 VA	2,500 VA
	Max. switching voltage	250 V AC	
	Max. switching current	16 A (AC)	10 A (AC)
	Min. switching load (reference value) *1	100 mA 5 V DC	
Insulation resistance (initial)		Min. 1,000 MΩ (at 500 V DC, Measured portion is the same as the case of dielectric strength.)	
Dielectric strength (initial)	Between open contacts	1,000 V rms for 1 min (detection current: 10 mA)	
	Between contact sets	—	2,000 V rms for 1 min (detection current: 10 mA)
	Between contact and coil	4,000 V rms for 1 min (detection current: 10 mA)	
Surge withstand voltage (initial) *2	Between contact and coil	10,000 V	
Time characteristics (initial)	Operate (Set) time	Max. 20 ms (Max. 20 ms) at rated coil voltage (at 20 °C, without bounce)	
	Release (Reset) time	Max. 20 ms (Max. 20 ms) at rated coil voltage (at 20 °C, without bounce, without diode)	
Shock resistance	Functional	200 m/s ² (half-sine shock pulse: 11 ms, detection time: 10 μs)	
	Destructive	1,000 m/s ² (half-sine shock pulse: 6 ms)	
Vibration resistance	Functional	10 to 55 Hz (at double amplitude of 2 mm, detection time: 10 μs)	
	Destructive	10 to 55 Hz (at double amplitude of 3 mm)	
Expected life	Mechanical life	Min. 5 × 10 ⁶ ope. (switching frequency: at 180 times/min)	
Conditions	Conditions for usage, transport and storage*3	Ambient temperature: -40 to +70 °C, Humidity: 5 to 85 % RH (Avoid icing and condensation)	
Unit weight		Approx. 14 g	

*1: This value can change due to the switching frequency, environmental conditions, and desired reliability level, therefore it is recommended to check this with the actual load.

*2: Wave is standard shock voltage of $\pm 1.2 \times 50 \mu\text{s}$ according to JEC-212-1981

*3: For ambient temperature, please read " GUIDELINES FOR RELAY USAGE ".

■ Expected electrical life

Conditions: Resistive load, switching frequency at 20 times/min

Type	Switching capacity	Number of operations
1 Form C, 1 Form A, 1 Form B	16 A 250 V AC	Min. 100 × 10 ³ ope.
1 Form A 1 Form B, 2 Form C, 2 Form A, 2 Form B	10 A 250 V AC	Min. 100 × 10 ³ ope.

Power Relays (Over 2 A) DJ RELAYS

REFERENCE DATA

1. Max. switching capacity

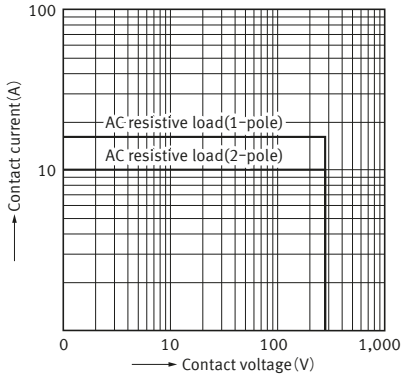

2. Coil temperature characteristics (Average)

Tested sample : ADJ55024, 6 pcs.
 Measured portion : Coil inside
 Contact current : 0A, 10A
 Coil applied voltage : 100%V, 130%V
 Ambient temperature : Room temperature, 70°C

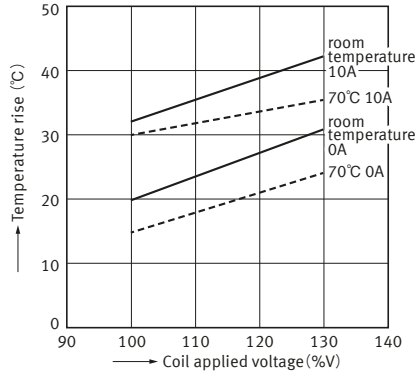

3. Ambient temperature characteristics (Average)

Tested sample : ADJ11024, 6 pcs.
 Ambient temperature : -40 to +85°C

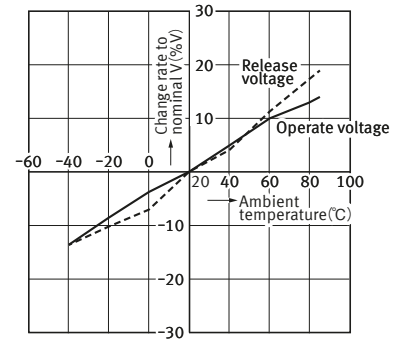

4. Temperature rise (Average)

Tested sample : ADJ11024, 6 pcs.
 Measured portion : Contact
 Contact current : 16A, 20A
 Coil applied voltage : 0%V
 Ambient temperature : 25°C, 85°C

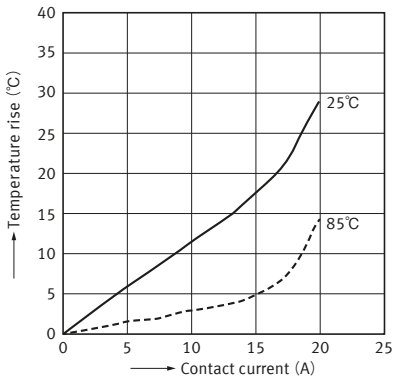

5. Set and Reset time

Tested sample : ADJ11024, 10 pcs.
 Coil applied voltage : 80%V, 100%V, 120%V

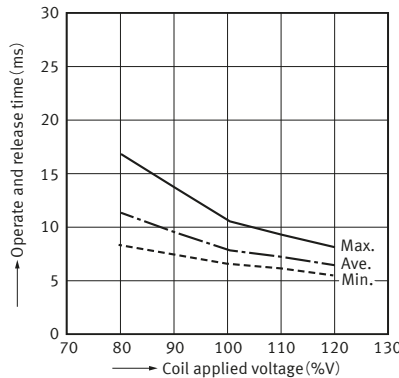

6. Influence of proximity mounting (Average)

Tested sample : ADJ11024, 6 pcs.
 Ambient temperature : Room temperature

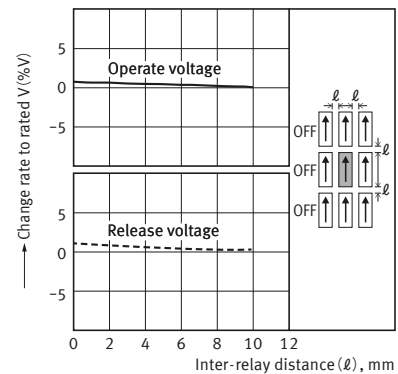

DIMENSIONS (Unit: mm)

CAD The CAD data of the products with a " CAD " mark can be downloaded from our Website.

1 Form C

Standard type

CAD

External dimensions

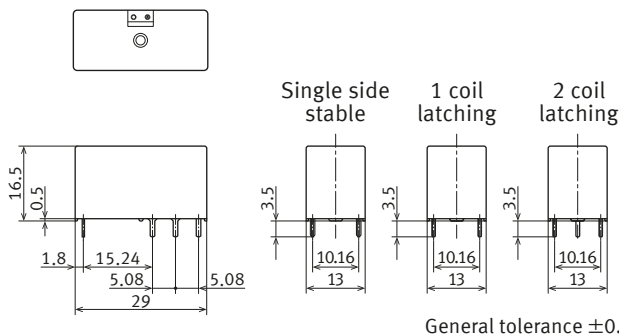

Recommended PC board pattern (BOTTOM VIEW)

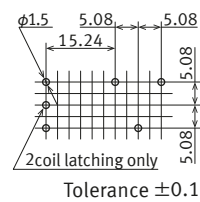

Schematic (BOTTOM VIEW) Single side stable (De-energize)

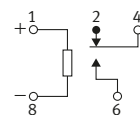

1 coil latching (Reset)

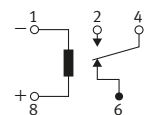

2 coil latching (Reset)

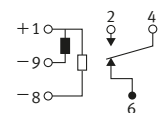

Power Relays (Over 2 A) DJ RELAYS

- With a test button

CAD

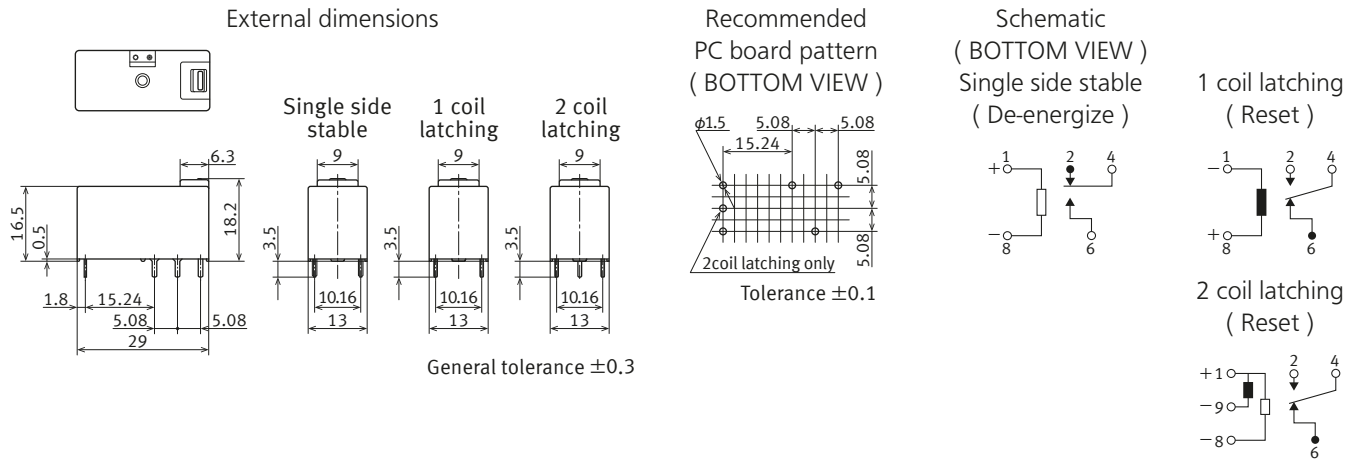

■ 1 Form A

- Standard type

CAD

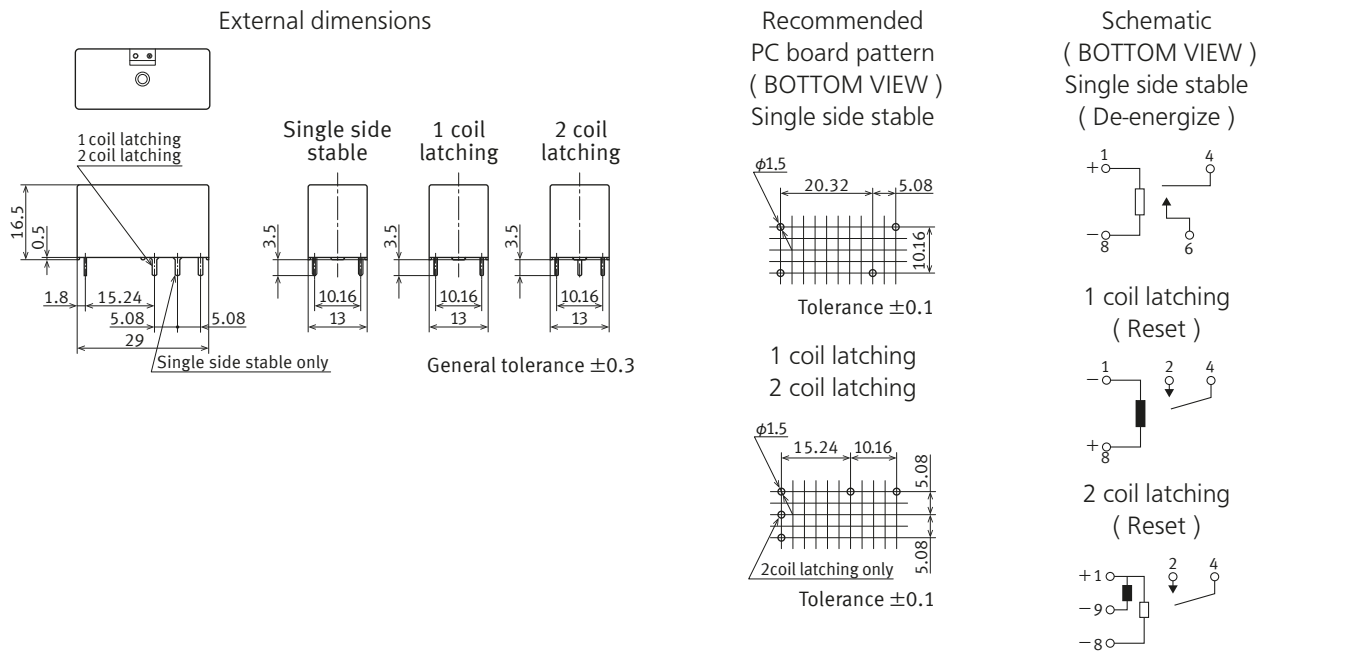

Power Relays (Over 2 A) DJ RELAYS

- With a test button

CAD

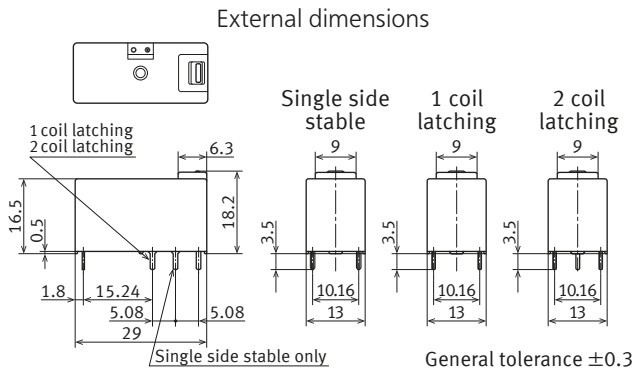

Recommended
PC board pattern
(BOTTOM VIEW)
Single side stable

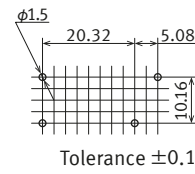

1 coil latching
2 coil latching

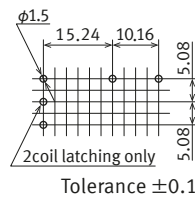

Schematic
(BOTTOM VIEW)
Single side stable
(De-energize)

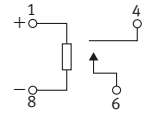

1 coil latching
(Reset)

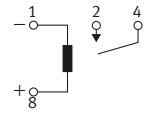

2 coil latching
(Reset)

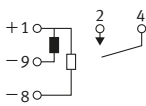

■ 1 Form B (Single side stable only)

- Standard type

CAD

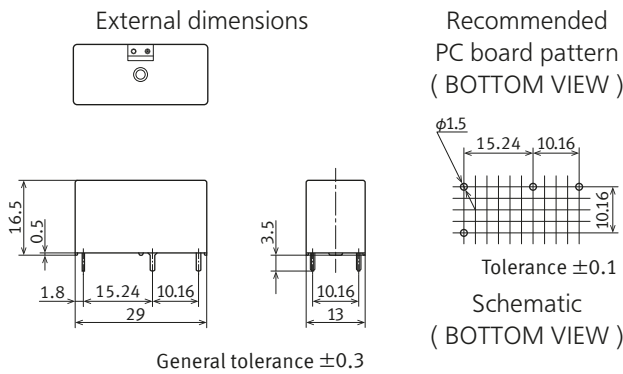

- With a test button

CAD

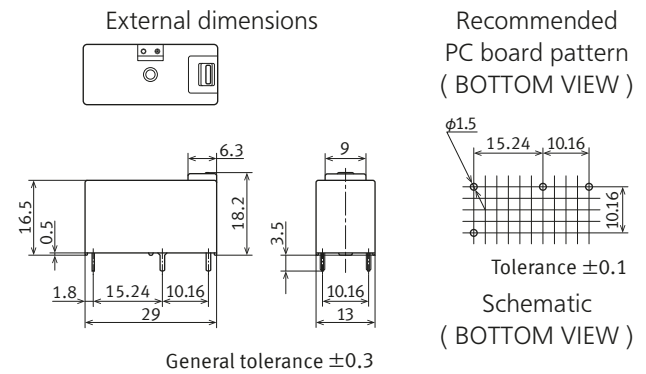

■ 1 Form A 1 Form B

- Standard type

CAD

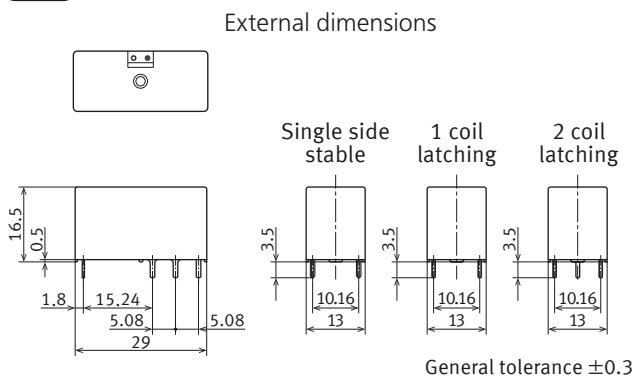

Recommended
PC board pattern
(BOTTOM VIEW)

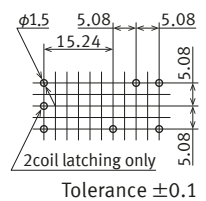

Schematic
(BOTTOM VIEW)
Single side stable
(De-energize)

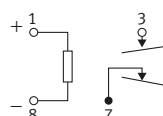

1 coil latching
(Reset)

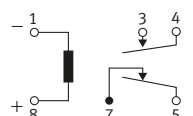

2 coil latching
(Reset)

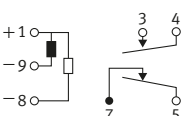

Power Relays (Over 2 A) DJ RELAYS

■ 2 Form C

● Standard type

CAD

External dimensions

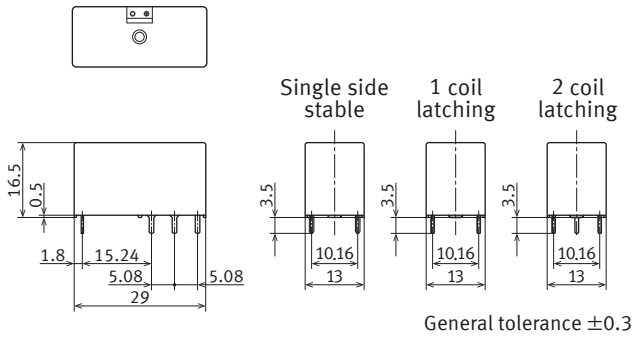

Recommended PC board pattern (BOTTOM VIEW)

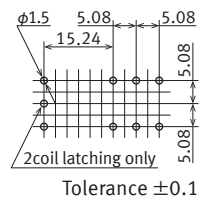

Schematic (BOTTOM VIEW)

Single side stable (De-energize)

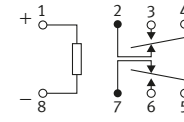

1 coil latching (Reset)

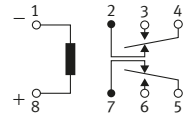

2 coil latching (Reset)

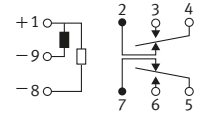

■ 2 Form A

● Standard type

CAD

External dimensions

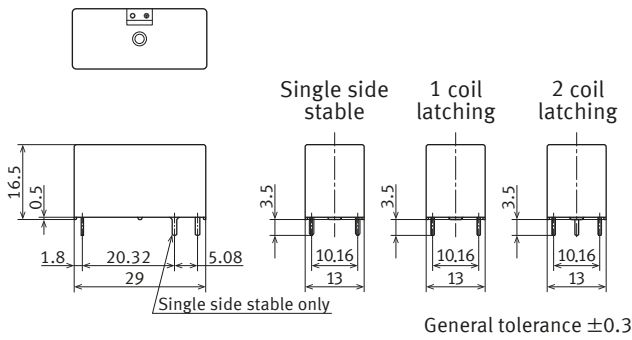

Recommended PC board pattern (BOTTOM VIEW)

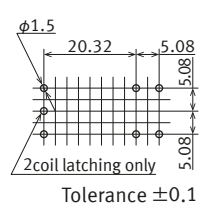

Schematic (BOTTOM VIEW)

Single side stable (De-energize)

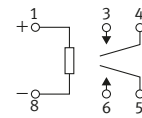

1 coil latching (Reset)

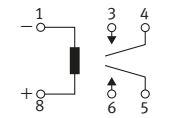

2 coil latching (Reset)

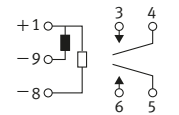

■ 2 Form B (Single side stable only)

● Standard type

CAD

External dimensions

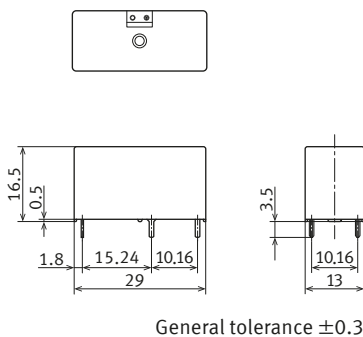

Recommended PC board pattern (BOTTOM VIEW)

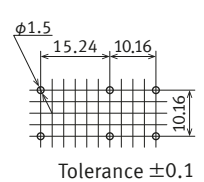

Schematic (BOTTOM VIEW)

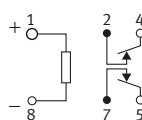

Power Relays (Over 2 A) DJ RELAYS

SAFETY STANDARDS

Each standard may be updated at any time, so please check our Website for the latest information.

■ UL/C-UL (Approved)

1 pole

File No.	Contact rating	Operations	Ambient temperature
E43149	20 A 277 V AC Resistive (1 Form A only)	20 × 10 ³	40 °C
	16 A 277 V AC Resistive	50 × 10 ³	40 °C

2 poles

File No.	Contact rating	Operations	Ambient temperature
E43149	10 A 277 V AC Resistive	100 × 10 ³	40 °C

■ CSA (Approved)

CSA standard approved by C-UL

■ CQC (Approved)

1 pole

File No.	Contact rating
CQC10002042641	16 A 250 V AC

2 poles

File No.	Contact rating
CQC10002042641	10 A 250 V AC

■ VDE (Approved)

1 pole

File No.	Contact rating
40009736	20 A 230 V AC (cos φ = 1.0) (1 Form A only)
	16 A 250 V AC (cos φ = 1.0)

2 poles

File No.	Contact rating
40009736	10 A 250 V AC (cos φ = 1.0)

INSULATION CHARACTERISTICS (IEC61810-1)

Item	Characteristics
Clearance/Creepage distance (IEC61810-1)	Min. 5.5/8.0 mm
Category of protection (IEC61810-1)	RT II
Tracking resistance (IEC60112)	PTI 175
Insulation material group	III a
Over voltage category	III
Rated voltage	250
Pollution degree	3
Type of insulation (Between contact and coil)	Reinforced insulation
Type of insulation (Between open contacts)	Micro disconnection

Note: EN/IEC VDE Certified.

GUIDELINES FOR USAGE

■ For cautions for use, please read " GUIDELINES FOR RELAY USAGE ".

https://industrial.panasonic.com/ac/e/control/relay/cautions_use/index.jsp

■ Cautions for usage of DJ relays

- Please be careful when using this relay (1 Form A 1 Form B), because when it operates and releases, the N.O. and N.C. turn ON simultaneously, which can cause harm to the circuit.

● Set and reset pulse time

Regarding the set and reset pulse time of the latching type, for the purpose of reliable operation under ambient temperature fluctuations and different operating conditions, we recommend setting the coil applied set and reset pulse time to 50 ms or more at the rated coil voltage.

● Test button (manual lever) operation

The relay contacts switch over as follows. (For 1 Form C)

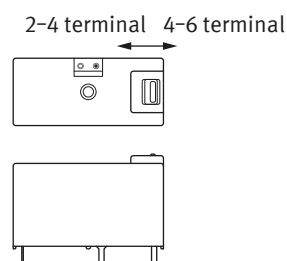

- For cautions for use, please read " GUIDELINES FOR RELAY USAGE ".
https://industrial.panasonic.com/ac/e/control/relay/cautions_use/index.jsp

Precautions for Coil Input

■ Long term current carrying

A circuit that will be carrying a current continuously for long periods without relay switching operation. (circuits for emergency lamps, alarm devices and error inspection that, for example, revert only during malfunction and output warnings with form B contacts) Continuous, long-term current to the coil will facilitate deterioration of coil insulation and characteristics due to heating of the coil itself. For circuits such as these, please use a magnetic-hold type latching relay. If you need to use a single stable relay, use a sealed type relay that is not easily affected by ambient conditions and make a failsafe circuit design that considers the possibility of contact failure or disconnection.

■ DC Coil operating power

Steady state DC current should be applied to the coil. The wave form should be rectangular. If it includes ripple, the ripple factor should be less than 5 %. However, please check with the actual circuit since the electrical characteristics may vary. The rated coil voltage should be applied to the coil and the set/reset pulse time of latching type relay differs for each relays, please refer to the relay's individual specifications.

■ Coil connection

When connecting coils of polarized relays, please check coil polarity (+ , -) at the internal connection diagram (Schematic). If any wrong connection is made, it may cause unexpected malfunction, like abnormal heat, fire and so on, and circuit do not work. Avoid impressing voltages to the set coil and reset coil at the same time.

■ Maximum allowable voltage and temperature rise

Proper usage requires that the rated coil voltage be impressed on the coil. Note, however, that if a voltage greater than or equal to the maximum continuous voltage is impressed on the coil, the coil may burn or its layers short due to the temperature rise. Furthermore, do not exceed the usable ambient temperature range listed in the catalog.

● Operate voltage change due to coil temperature rise

In DC relays, after continuous passage of current in the coil, if the current is turned OFF, then immediately turned ON again, due to the temperature rise in the coil, the operate voltage will become somewhat higher. Also, it will be the same as using it in a higher temperature atmosphere. The resistance/temperature relationship for copper wire is about 0.4 % for 1 °C, and with this ratio the coil resistance increases. That is, in order to operate of the relay, it is necessary that the voltage be higher than the operate voltage and the operate voltage rises in accordance with the increase in the resistance value. However, for some polarized relays, this rate of change is considerably smaller.

Ambient Environment

Usage, Transport, and Storage Conditions

During usage, storage, or transportation, avoid locations subjected to direct sunlight and maintain normal temperature, humidity and pressure conditions.

Temperature/Humidity/Pressure

When transporting or storing relays while they are tube packaged, there are cases the temperature may differ from the allowable range. In this case be sure to check the individual specifications.

Also allowable humidity level is influenced by temperature, please check charts shown below and use relays within mentioned conditions. (Allowable temperature values differ for each relays, please refer to the relay's individual specifications.)

1) Temperature:

The tolerance temperature range differs for each relays, please refer to the relay's individual specifications

2) Humidity: 5 to 85 % RH

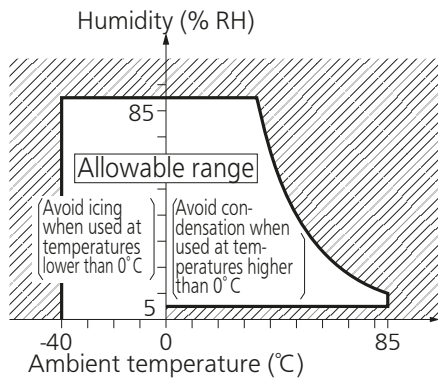

3) Pressure: 86 to 106 kPa

Dew condensation

Condensation occurs when the ambient temperature drops suddenly from a high temperature and humidity, or the relay is suddenly transferred from a low ambient temperature to a high temperature and humidity.

Condensation causes the failures like insulation deterioration, wire disconnection and rust etc.

Panasonic Industry Co., Ltd. does not guarantee the failures caused by condensation.

The heat conduction by the equipment may accelerate the cooling of device itself, and the condensation may occur.

Please conduct product evaluations in the worst condition of the actual usage. (Special attention should be paid when high temperature heating parts are close to the device. Also please consider the condensation may occur inside of the device.)

Icing

Condensation or other moisture may freeze on relays when the temperature become lower than 0 °C. This icing causes the sticking of movable portion, the operation delay and the contact conduction failure etc. Panasonic Industry Co., Ltd. does not guarantee the failures caused by the icing.

The heat conduction by the equipment may accelerate the cooling of relay itself and the icing may occur. Please conduct product evaluations in the worst condition of the actual usage.

Low temperature and low humidity

The plastic becomes brittle if the relay is exposed to a low temperature, low humidity environment for long periods of time.

High temperature and high humidity

Storage for extended periods of time (including transportation periods) at high temperature or high humidity levels or in atmospheres with organic gases or sulfide gases may cause a sulfide film or oxide film to form on the surfaces of the contacts and/or it may interfere with the functions. Check out the atmosphere in which the units are to be stored and transported.

Package

In terms of the packing format used, make every effort to keep the effects of moisture, organic gases and sulfide gases to the absolute minimum.

Silicon

When a source of silicone substances (silicone rubber, silicone oil, silicone coating materials and silicone filling materials etc.) is used around the relay, the silicone gas (low molecular siloxane etc.) may be produced.

This silicone gas may penetrate into the inside of the relay. When the relay is kept and used in this condition, silicone compound may adhere to the relay contacts which may cause the contact failure. Do not use any sources of silicone gas around the relay (Including plastic sealed types).

NOx Generation

When relay is used in an atmosphere high in humidity to switch a load which easily produces an arc, the NOx created by the arc and the water absorbed from outside the relay combine to produce nitric acid.

This corrodes the internal metal parts and adversely affects operation.

Avoid use at an ambient humidity of 85 % RH or higher (at 20 °C). If use at high humidity is unavoidable, please contact our sales representative.

Others

■ Cleaning

- Although the environmentally sealed type relay (plastic sealed type, etc.) can be cleaned, avoid immersing the relay into cold liquid (such as cleaning solvent) immediately after soldering. Doing so may deteriorate the sealing performance.
- Cleaning with the boiling method is recommended (The temperature of cleaning liquid should be 40 °C or lower). Avoid ultrasonic cleaning on relays. Use of ultrasonic cleaning may cause breaks in the coil or slight sticking of the contacts due to ultrasonic energy.

Please refer to "**the latest product specifications**" when designing your product.

- Requests to customers:

<https://industrial.panasonic.com/ac/e/salespolicies/>

■ Global Sales Network Information: industrial.panasonic.com/ac/e/salesnetwork

Panasonic
INDUSTRY

Panasonic Industry Co., Ltd.

Electromechanical Control Business Division

■ 1006, Oaza Kadoma, Kadoma-shi, Osaka 571-8506, Japan
industrial.panasonic.com/ac/e/