

## LF RELAYS

### Ideal for compressor and inverter loads, 1 Form A 20 A, Power relays

Protective construction : Flux-resistant type

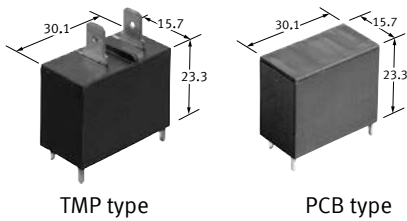

(Unit : mm)

#### FEATURES

- Ideal for compressor and inverter loads
- Insulation distance (between contact and coil):  
Clearance Min. 8 mm and Creepage Min. 9.5 mm
- Surge withstand voltage: 10,000 V
- TMP type/PCB type

#### TYPICAL APPLICATIONS

- Air conditioner
- Refrigerators
- OA equipment

#### ORDERING INFORMATION (PART NO.)

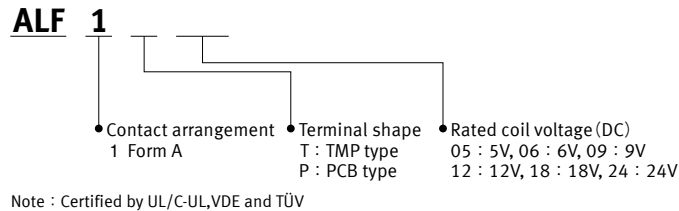

#### TYPES

Contact arrangement	Rated coil voltage	Part No.		Standard packing	
		TMP type	PCB type	Inner carton	Outer carton
1 Form A	5 V DC	ALF1T05	ALF1P05	50 pcs.	200 pcs.
	6 V DC	ALF1T06	ALF1P06		
	9 V DC	ALF1T09	ALF1P09		
	12 V DC	ALF1T12	ALF1P12		
	18 V DC	ALF1T18	ALF1P18		
	24 V DC	ALF1T24	ALF1P24		

# Power relays (Over 2 A) LF RELAYS

## RATING

### Coil data

- Operating characteristics such as 'Operate voltage' and 'Release voltage' are influenced by mounting conditions, ambient temperature, etc.

Therefore, please use the relay within  $\pm 5\%$  of rated coil voltage.

- 'Initial' means the condition of products at the time of delivery.

Rated coil voltage	Operate voltage* (at 20°C)	Release voltage* (at 20°C)	Rated operating current ( $\pm 10\%$ , at 20°C)	Coil resistance ( $\pm 10\%$ , at 20°C)	Rated operating power	Max. allowable voltage (at 60°C)
5 V DC	Max. 70% V of rated coil voltage (Initial)	Min. 10% V of rated coil voltage (Initial)	180 mA	27.8 $\Omega$	900 mW	110% V of rated coil voltage
6 V DC			150 mA	40 $\Omega$		
9 V DC			100 mA	90 $\Omega$		
12 V DC			75 mA	160 $\Omega$		
18 V DC			50 mA	360 $\Omega$		
24 V DC			37.5 mA	640 $\Omega$		

\*square, pulse drive

### Specifications

Item	Specifications	
Contact data	Contact arrangement	1 Form A
	Contact resistance (initial)	Max. 100 m $\Omega$ (by voltage drop 6 V DC 1 A)
	Contact material	AgSnO <sub>2</sub> type
	Contact rating (resistive)	20 A 250 V AC
	Max. switching power (resistive)	6,250 VA
	Max. switching voltage	250 V AC
	Max. switching current	25 A (AC)
	Min. switching load (reference value)* <sup>1</sup>	100 mA 5 V DC
Insulation resistance (initial)	Min. 1,000 M $\Omega$ (at 500 V DC, Measured portion is the same as the case of dielectric strength.)	
Dielectric strength (initial)	Between open contacts	1,000 V AC for 1 min (detection current: 10 mA)
	Between contact and coil	5,000 V AC for 1 min (detection current: 10 mA)
Surge withstand voltage (initial)* <sup>2</sup>	Between contact and coil	10,000 V
Time characteristics (initial)	Operate time	Max. 20 ms at rated coil voltage (at 20°C, without bounce)
	Release time	Max. 15 ms at rated coil voltage (at 20°C, without bounce, with diode)
Shock resistance	Functional	100 m/s <sup>2</sup> (half-sine shock pulse: 11 ms, detection time: 10 $\mu$ s)
	Destructive	1,000 m/s <sup>2</sup> (half-sine shock pulse: 6 ms)
Vibration resistance	Functional	10 to 55 Hz (at double amplitude of 1.5 mm, detection time: 10 $\mu$ s)
	Destructive	10 to 55 Hz (at double amplitude of 1.5 mm)
Expected life	Mechanical life	Min. 2 x 10 <sup>6</sup> (switching frequency: 180 times/min)
Conditions	Conditions for usage, transport and storage* <sup>3</sup>	Ambient temperature: -40 to +60°C, Humidity: 5 to 85% RH (Avoid icing and condensation)
Unit weight		Approx. 23 g

\*1. This value can change due to the switching frequency, environmental conditions, and desired reliability level, therefore it is recommended to check this with the actual load.

\*2. Wave is standard shock voltage of  $\pm 1.2 \times 50 \mu$ s according to JEC-212-1981

\*3. For ambient temperature, please read "GUIDELINES FOR RELAY USAGE".

### Expected electrical life

Conditions: at 20°C

Type	Load	Switching capacity	Number of operations
1 Form A	Resistive load	20 A 250 V AC ( $\cos\phi = 1.0$ )	Min. 100 x 10 <sup>3</sup> (switching frequency 20 times/min)
		25 A 250 V AC ( $\cos\phi = 1.0$ )	Min. 10 x 10 <sup>3</sup> (switching frequency 20 times/min)
	Inverter load	Inrush 70 A ( $\cos\phi = 0.7$ ), Steady 20 A ( $\cos\phi = 0.9$ ) 250 V AC	Min. 100 x 10 <sup>3</sup> (switching frequency 20 times/min)
		Inrush 200 A, Steady 20 A 100 V AC	Min. 30 x 10 <sup>3</sup> (switching frequency 10 times/min)
		Inrush 100 A, Steady 10 A 200 V AC	Min. 30 x 10 <sup>3</sup> (switching frequency 10 times/min)

REFERENCE DATA

1. Switching life curve

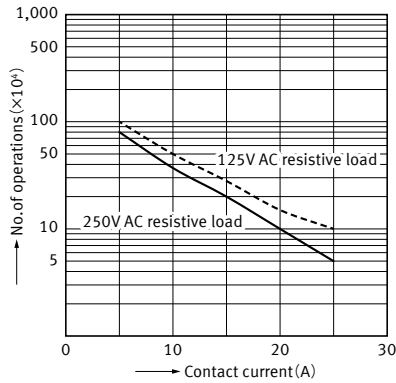

2. Coil temperature characteristics (Average)

Tested sample : ALF1T12, 6 pcs.  
 Measured portion : Coil inside  
 Contact current : 20A  
 Ambient temperature : 25°C, 60°C

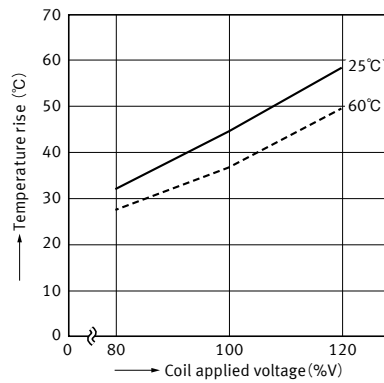

3-1. 200 V AC Electrical life test (200 V AC Inverter load)

Tested sample : ALF1T12, 6 pcs.  
 Load : Inrush 102A (wave peak value),  
 Steady 14.4A (wave peak value)  
 Inverter dummy 200V AC  
 Operation frequency : ON : OFF=1s : 5s  
 Circuit :

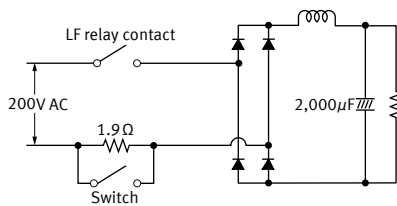

Change of operate and release voltage

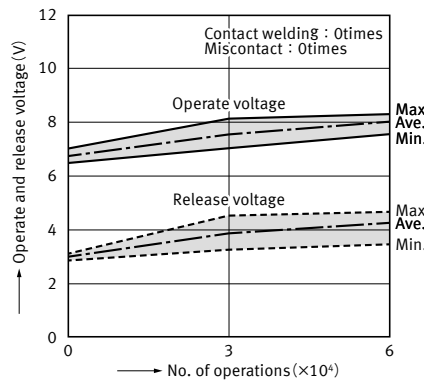

3-2. 100 V AC Electrical life test (100 V AC Inverter load)

Tested sample : ALF1T12, 6 pcs.  
 Load : Inrush 224A (wave peak value),  
 Steady 30.5A (wave peak value)  
 Inverter dummy 100V AC  
 Operation frequency : ON : OFF=1s : 5s  
 Circuit :

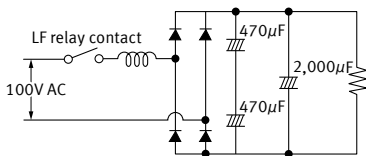

Change of operate and release voltage

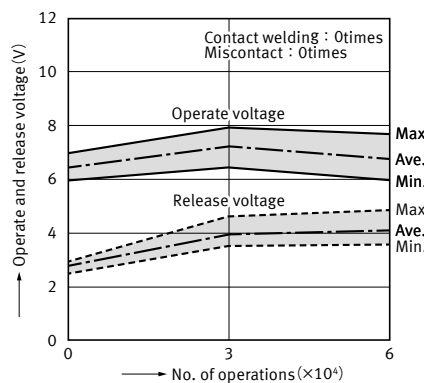

# Power relays (Over 2 A) LF RELAYS

## 3-3.250 V AC Electrical life test (250 V AC Compressor dummy load)

Tested sample : ALF1T12, 6 pcs.  
 Load : Inrush 70.7A,  $\cos\phi=0.7$   
 Steady 20A,  $\cos\phi=0.9$   
 compressor dummy 250V AC  
 Operation frequency : ON : OFF=1.5s : 1.5s  
 Circuit :

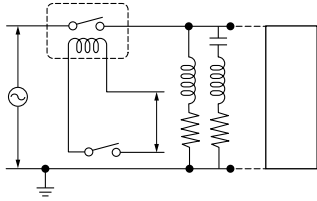

Change of operate and release voltage

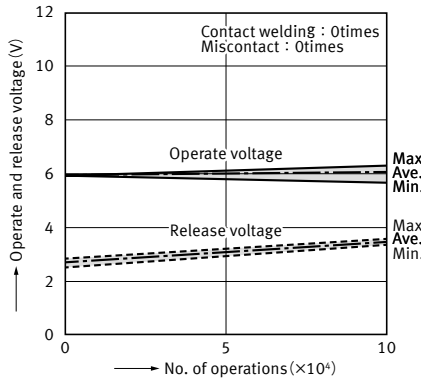

## 3-4. Electrical life test

(20 A 250 V AC Resistive load)

Tested sample : ALF1T12, 6 pcs.  
 Operation frequency : ON : OFF=1.5s : 1.5s

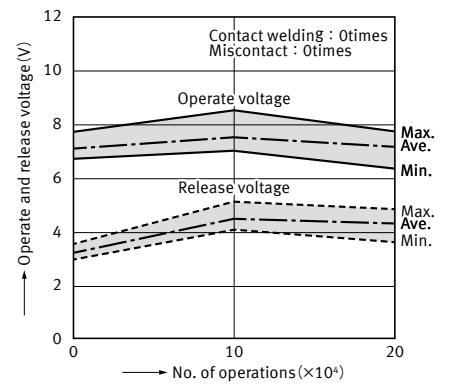

### DIMENSIONS

**CAD** The CAD data of the products with a "CAD" mark can be downloaded from our Website.

Unit: mm

#### ■ TMP type

##### CAD



External dimensions

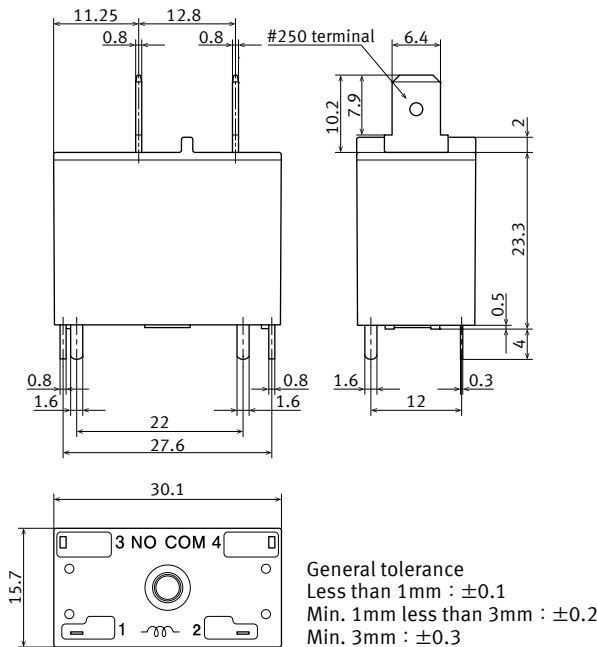

Schematic (BOTTOM VIEW)

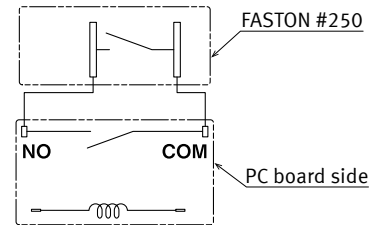

Recommended PC board pattern (BOTTOM VIEW)

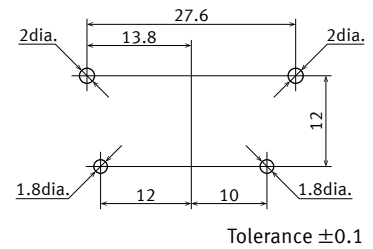

#### ■ PCB type

##### CAD



External dimensions

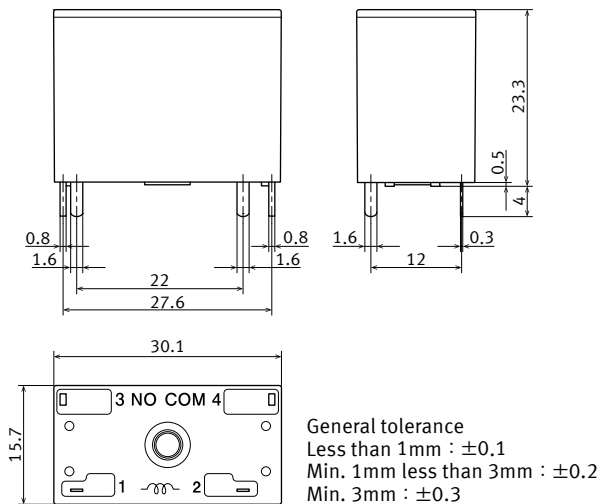

Schematic (BOTTOM VIEW)

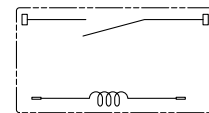

Recommended PC board pattern (BOTTOM VIEW)

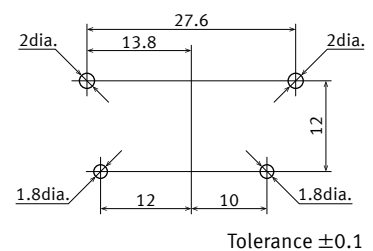

**SAFETY STANDARDS**

Each standard may be updated at any time, so please check our Website for the latest information.

**UL/C-UL (Recognized)**

File No.	Contact rating	Operations	Ambient temperature
E43028	25 A 277 V AC Resistive	6 × 10 <sup>3</sup>	40°C
	20 A 277 V AC Resistive	100 × 10 <sup>3</sup>	40°C

**VDE (Certified)**

File No.	Contact rating	Operations	Ambient temperature
40009169	20 A 250 V AC (cosφ = 1.0)	10 × 10 <sup>3</sup>	60°C
	10 A 250 V AC (cosφ = 0.4)	100 × 10 <sup>3</sup>	70°C

**TV rating**

File No.	Contact rating
UL: E43028	TV-8

**CSA (Certified)**

CSA standard certified by C-UL

**TÜV (Certified)**

File No.	Contact rating	Operations	Ambient temperature
B 12 06 13461 326	20 A 250 V AC (cosφ = 1.0)	10 × 10 <sup>3</sup>	60°C

**INSULATION CHARACTERISTICS (IEC61810-1)**

Item	Characteristics
Clearance/Creepage distance (IEC61810-1)	Min. 5.5 /5.5 mm
Category of protection (IEC61810-1)	RT II
Tracking resistance (IEC60112)	PTI 175
Insulation material group	III a
Over voltage category	III
Rated voltage	250 V
Pollution degree	2
Type of insulation (Between contact and coil)	Reinforced insulation
Type of insulation (Between open contacts)	Micro disconnection

Note: Actual value

**GUIDELINES FOR USAGE**

- For cautions for use, please read “GUIDELINES FOR RELAY USAGE”.  
[https://industrial.panasonic.com/ac/e/control/relay/cautions\\_use/index.jsp](https://industrial.panasonic.com/ac/e/control/relay/cautions_use/index.jsp)

# GUIDELINES FOR POWER, HIGH-CAPACITY DC CUT OFF AND SAFETY RELAYS USAGE

■ For cautions for use, please read “GUIDELINES FOR RELAY USAGE”.  
[https://industrial.panasonic.com/ac/e/control/relay/cautions\\_use/index.jsp](https://industrial.panasonic.com/ac/e/control/relay/cautions_use/index.jsp)

## Precautions for Coil Input

### ■ Long term current carrying

A circuit that will be carrying a current continuously for long periods without relay switching operation. (circuits for emergency lamps, alarm devices and error inspection that, for example, revert only during malfunction and output warnings with form B contacts)  
Continuous, long-term current to the coil will facilitate deterioration of coil insulation and characteristics due to heating of the coil itself. For circuits such as these, please use a magnetic-hold type latching relay. If you need to use a single stable relay, use a sealed type relay that is not easily affected by ambient conditions and make a failsafe circuit design that considers the possibility of contact failure or disconnection.

### ■ DC Coil operating power

Steady state DC current should be applied to the coil. The wave form should be rectangular. If it includes ripple, the ripple factor should be less than 5%.

However, please check with the actual circuit since the electrical characteristics may vary. The rated coil voltage should be applied to the coil and the set/reset pulse time of latching type relay differs for each relays, please refer to the relay's individual specifications.

### ■ Coil connection

When connecting coils of polarized relays, please check coil polarity (+,-) at the internal connection diagram (Schematic). If any wrong connection is made, it may cause unexpected malfunction, like abnormal heat, fire and so on, and circuit do not work. Avoid impressing voltages to the set coil and reset coil at the same time.

### ■ Maximum allowable voltage and temperature rise

Proper usage requires that the rated coil voltage be impressed on the coil. Note, however, that if a voltage greater than or equal to the maximum continuous voltage is impressed on the coil, the coil may burn or its layers short due to the temperature rise. Furthermore, do not exceed the usable ambient temperature range listed in the catalog.

### ■ Operate voltage change due to coil temperature rise

In DC relays, after continuous passage of current in the coil, if the current is turned OFF, then immediately turned ON again, due to the temperature rise in the coil, the pick-up voltage will become somewhat higher. Also, it will be the same as using it in a higher temperature atmosphere. The resistance/temperature relationship for copper wire is about 0.4% for 1°C, and with this ratio the coil resistance increases. That is, in order to operate of the relay, it is necessary that the voltage be higher than the pick-up voltage and the pick-up voltage rises in accordance with the increase in the resistance value. However, for some polarized relays, this rate of change is considerably smaller.

## Ambient Environment

### ■ Usage, Transport, and Storage Conditions

During usage, storage, or transportation, avoid locations subjected to direct sunlight and maintain normal temperature, humidity and pressure conditions.

### ● Temperature/Humidity/Pressure

When transporting or storing relays while they are tube packaged, there are cases the temperature may differ from the allowable range. In this case be sure to check the individual specifications. Also allowable humidity level is influenced by temperature, please check charts shown below and use relays within mentioned conditions. (Allowable temperature values differ for each relays, please refer to the relay's individual specifications.)

#### 1) Temperature:

The tolerance temperature range differs for each relays, please refer to the relay's individual specifications

#### 2) Humidity: 5 to 85 % RH

#### 3) Pressure: 86 to 106 kPa

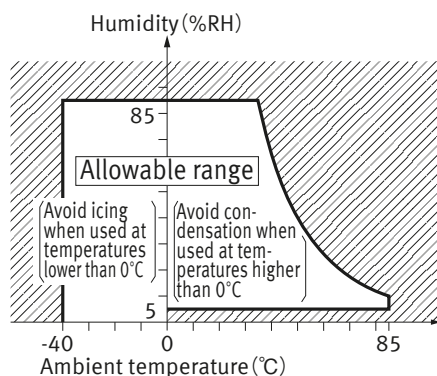

### ● Dew condensation

Condensation occurs when the ambient temperature drops suddenly from a high temperature and humidity, or the relay is suddenly transferred from a low ambient temperature to a high temperature and humidity. Condensation causes the failures like insulation deterioration, wire disconnection and rust etc. Panasonic Corporation does not guarantee the failures caused by condensation.

The heat conduction by the equipment may accelerate the cooling of device itself, and the condensation may occur.

Please conduct product evaluations in the worst condition of the actual usage. (Special attention should be paid when high temperature heating parts are close to the device. Also please consider the condensation may occur inside of the device.)

### ● Icing

Condensation or other moisture may freeze on relays when the temperature become lower than 0°C. This icing causes the sticking of movable portion, the operation delay and the contact conduction failure etc. Panasonic Corporation does not guarantee the failures caused by the icing.

The heat conduction by the equipment may accelerate the cooling of relay itself and the icing may occur. Please conduct product evaluations in the worst condition of the actual usage.

### ● Low temperature and low humidity

The plastic becomes brittle if the switch is exposed to a low temperature, low humidity environment for long periods of time.

### ● High temperature and high humidity

Storage for extended periods of time (including transportation periods) at high temperature or high humidity levels or in atmospheres with organic gases or sulfide gases may cause a sulfide film or oxide film to form on the surfaces of the contacts and/or it may interfere with the functions. Check out the atmosphere in which the units are to be stored and transported.

## ● Package

In terms of the packing format used, make every effort to keep the effects of moisture, organic gases and sulfide gases to the absolute minimum.

## ● Silicon

When a source of silicone substances (silicone rubber, silicone oil, silicone coating materials and silicone filling materials etc.) is used around the relay, the silicone gas (low molecular siloxane etc.) may be produced.

This silicone gas may penetrate into the inside of the relay. When the relay is kept and used in this condition, silicone compound may adhere to the relay contacts which may cause the contact failure.

Do not use any sources of silicone gas around the relay (Including plastic seal types).

## ● NOx Generation

When relay is used in an atmosphere high in humidity to switch a load which easily produces an arc, the NOx created by the arc and the water absorbed from outside the relay combine to produce nitric acid.

This corrodes the internal metal parts and adversely affects operation.

Avoid use at an ambient humidity of 85%RH or higher (at 20°C). If use at high humidity is unavoidable, please contact our sales representative.

## Others

### ■ Cleaning

• Although the environmentally sealed type relay (plastic sealed type, etc.) can be cleaned, avoid immersing the relay into cold liquid (such as cleaning solvent) immediately after soldering. Doing so may deteriorate the sealing performance.

• Cleaning with the boiling method is recommended(The temperature of cleaning liquid should be 40°C or lower ).

Avoid ultrasonic cleaning on relays. Use of ultrasonic cleaning may cause breaks in the coil or slight sticking of the contacts due to ultrasonic energy.

Please refer to **"the latest product specifications"** when designing your product.

•Requests to customers:

<https://industrial.panasonic.com/ac/e/salespolicies/>

---

Please contact .....

**Panasonic Corporation**

Electromechanical Control Business Division

■1006, Oaza Kadoma, Kadoma-shi, Osaka 571-8506, Japan  
[industrial.panasonic.com/ac/e/](http://industrial.panasonic.com/ac/e/)

**Panasonic**<sup>®</sup>

©Panasonic Corporation 2021