

Amplifier Built-in

## Adjustable Range Reflective Compact Photoelectric Sensor

CX-440 SERIES Ver.2

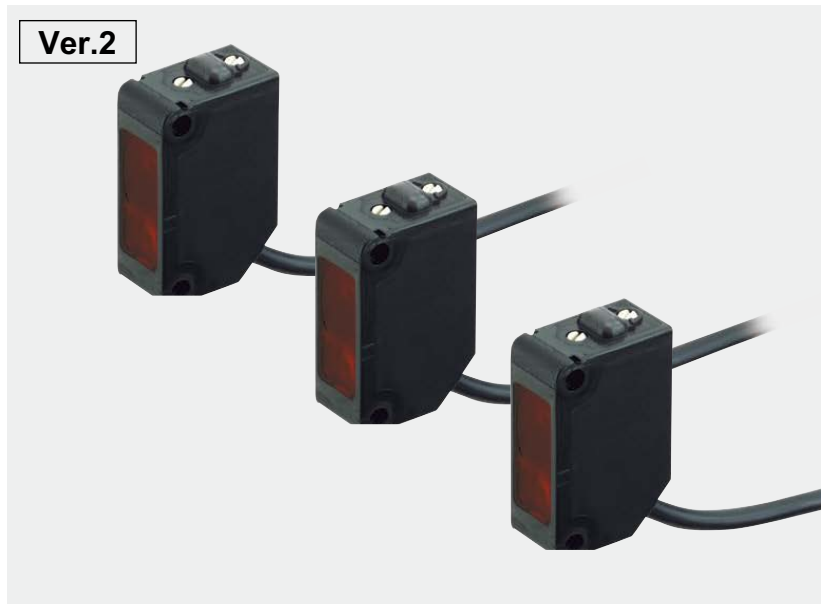

**CX-440** SERIES Ver.2

Ver.2



## 2% hysteresis - demonstrates power in level difference sensing and heterochromatic object stability sensing

Can sense differences as small as 0.4 mm **0.016 in.** with hysteresis of 2 % or less **CX-441/443**

An advanced optical system provides sensing performance that is 2.5 times approx. than conventional models. Even ultra-small differences of 0.4 mm **0.016 in** can be detected accurately.

2.5 times the sensing capability!

Height differences of as little as 0.4 mm **0.016 in** can be detected at a setting distance of 20 mm **0.787 in**



Hardly affected by colors

**CX-441/443**

Both black and white objects can be sensed at the same distances. No adjuster control is needed, even when products of different colors are moving along the production line.

30 % higher sensing capability



[The difference in sensing ranges is 1% or less between non-glossy white paper with a setting distance of 50 mm **1.969 in** and non-glossy gray paper with a brightness level of 5.]

## ENVIRONMENTAL RESISTANCE

### Strong against ethanol

A strong, ethanol resistant polycarbonate was used for the front and display covers. Safe even for installing near food processing machinery that disperses ethanol based detergents. The protection mechanism also conforms to IP67 (IEC).



### Stronger noise resistance

Significantly stronger against inverter light and other extraneous light as well as high frequency and electromagnetic noise.

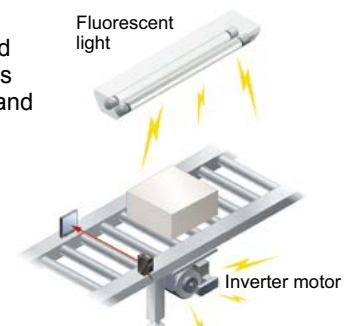

### Strong even in cold environments

Stable performance can be maintained even in environments of  $-25\text{ }^{\circ}\text{C}$   **$-13\text{ }^{\circ}\text{F}$** .

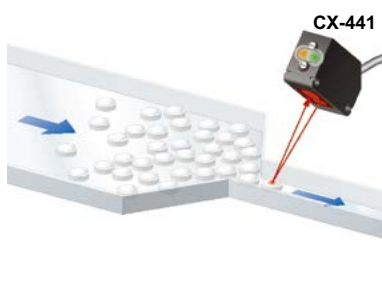
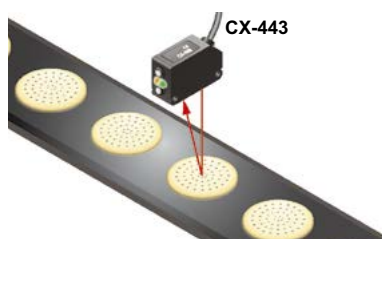
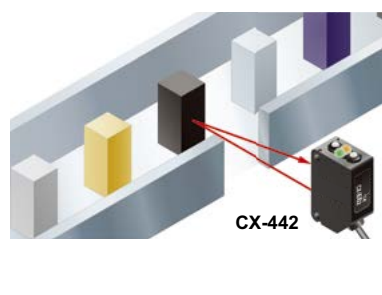
**APPLICATIONS****Small tablet detection****Thin biscuit detection****Passage confirmation of a different color object****FUNCTIONS**

**BGS/FGS functions make even the most challenging settings possible!**

**The BGS function is best suited for the following case**

**Background not present**

When object and background are separated

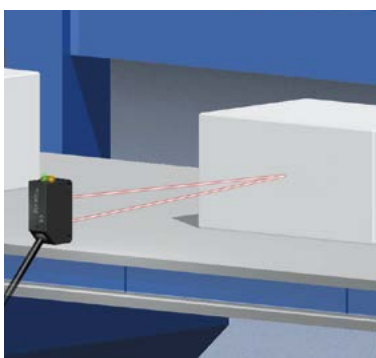
**BGS**

Not affected if the background color changes or someone passes behind the conveyor.

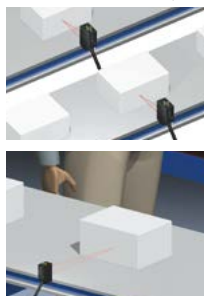

**The FGS function is best suited for the following case**

**Background present**

When object and background are close together  
When the object is glossy or uneven

**FGS**

Unaffected by gloss, color or uneven surfaces when sensing objects present on a conveyor belt.

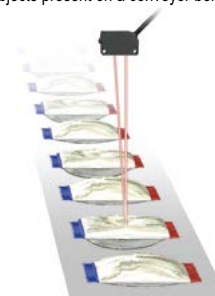

Caution : Please use the FGS function together with a conveyor or other background unit.

**ORDER GUIDE**

Type	Appearance	Sensing range	Model No.		Emitting element
			NPN output	PNP output	
Adjustable range reflective Small spot		2 to 50 mm 0.079 to 1.969 in	<b>CX-441</b>	<b>CX-441-P</b>	Red LED
		15 to 100 mm 0.591 to 3.937 in	<b>CX-443</b>	<b>CX-443-P</b>	
		20 to 300 mm 0.787 to 11.811 in	<b>CX-444</b>	<b>CX-444-P</b>	
			<b>CX-442</b>	<b>CX-442-P</b>	

NOTE: Mounting bracket is not supplied with the sensor. Please select from the range of optional sensor mounting brackets.

**M8 plug-in connector type**

M8 plug-in connector type is also available.

When ordering this type, suffix "-Z" for the M8 connector type to the model No.  
(e.g.) M8 connector type of **CX-441-P** is "**CX-441-P-Z**".

## Disclaimer

The applications described in the catalog are all intended for examples only. The purchase of our products described in the catalog shall not be regarded as granting of a license to use our products in the described applications. We do NOT warrant that we have obtained some intellectual properties, such as patent rights, with respect to such applications, or that the described applications may not infringe any intellectual property rights, such as patent rights, of a third party.

**Panasonic**  
INDUSTRY

**Panasonic Industry Co., Ltd.**

Industrial Device Business Division

7-1-1, Morofuku, Daito-shi, Osaka 574-0044, Japan

[industrial.panasonic.com/ac/e/](http://industrial.panasonic.com/ac/e/)